

# LIRT

## LED INSET THRESHOLD LIGHT



### COMPLIANCES

ICAO: Annex 14 - Volume I Fig. A2-3  
 FAA: L-850E(L) AC150/5345-46 and EB No.67  
 IEC: TS 61827  
 NATO: STANAG 3316  
 CAA: CAP 168  
 IAAE: TP312

### APPLICATIONS

Threshold for ICAO CAT I, II and III, FAA and military runways

### BENEFITS

- 60000 hours LED rated life at full intensity, but over 100000 hours in field operating conditions
- In new installation, LED lights mean lower loads, lower size of CCRs and transformers, thus low life cycle costs
- The light output is variable like a traditional halogen lamp, as indicated by the FAA "Engineering Briefing No.67"
- Colour emitted directly by LEDs: absence of coloured filters ensures no energy losses and no colour shifts
- Fully compatible with existing AFL infrastructure\*
- Designed with simplicity allowing longer maintenance intervals and fewer spare parts
- No use of sealant to fix the prisms in the dome thanks to customized gaskets, making their replacement quick and easy
- No optical adjustment after LED module or prism replacement
- Valve for watertightness test after overhaul
- Operating with any topology of CCRs designed in compliance with IEC or FAA requirements

\* For monitored fixtures, isolation transformer max size: 200VA

### PERFORMANCES

- The electronic is strong-built and highly resistant to shock and vibration
- Automatic adaptation to the frequency of the supply current
- A surge protection device is provided in the electronics as required by the FAA "Engineering Briefing No.67"
- Immediate detection of an internal fault
- 6.35 mm protrusion strongly reduces vibrations to aircrafts and to light itself, increasing its lifetime
- Dome smooth outer profile makes the light less sensitive to snowplough blades
- Unidirectional, 12" dia.
- Drop-forged dome and cast aluminium lower cover make the fitting sturdy, but lightweight too for ease handling in the field
- Light output practically not affected by heavy rainfall thanks to the shallow channel in front of the prism windows
- O-Ring placed outside the dome to avoid dirt deposits between light and base
- Protection degree: IP67
- Temperature range: -55°C to +55°C

### INSTALLATION

- Suitable for 12" dia. bases
- Specific tools available for easy and precise installation

### PHOTOMETRIC PERFORMANCES

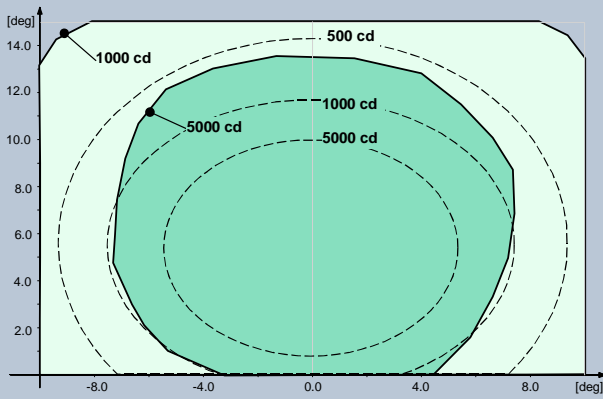

Fig. 1 ICAO A2-3 – Green

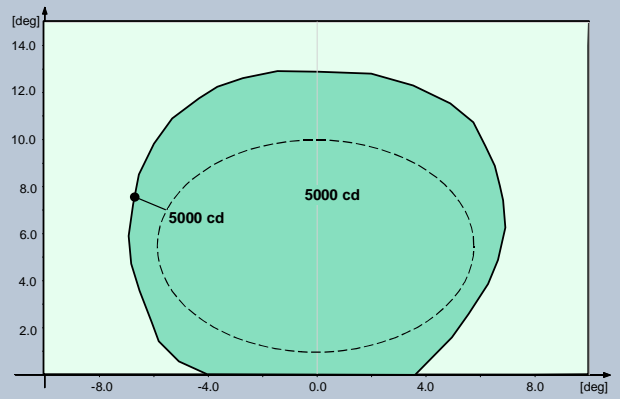
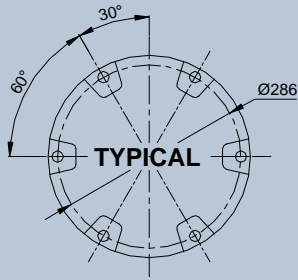

Fig. 2 FAA L-850E – Green

### TABLES

POWER CONSUMPTION*	
Electrical System	1 Plug
Unidirectional (w/o Arctic Kit)	36 VA
Unidirectional (with Arctic Kit)	76 VA
* Measured at 6.6 A and referred to the highest consumption configuration	

POWER FACTOR		
Input Step	2.8 A	6.6 A
Power Factor	0.96	0.98



Light Fixture 12" dia.

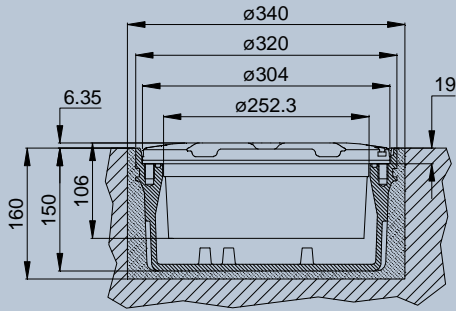

Shallow Base 12" dia.

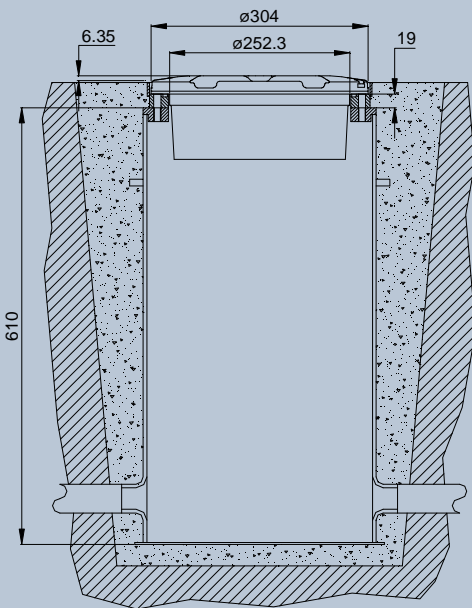

L-868 Deep Base 12" dia.

**LIRT- F - L - M - A**

**Basic P/N:** \_\_\_\_\_

**Compliance\*:** \_\_\_\_\_

F = FAA

I = ICAO

**Toe-in\*\*:** \_\_\_\_\_

R = Left

L = Right

S = Straight

**Monitoring:** \_\_\_\_\_

O = Without Monitoring

M = With Monitoring

**Arctic Kit:** \_\_\_\_\_

O = Without Arctic Kit

A = With Arctic Kit

\* Compliance "F" must be combined with Toe-in "S" only

\*\* The beam aiming is not field adjustable

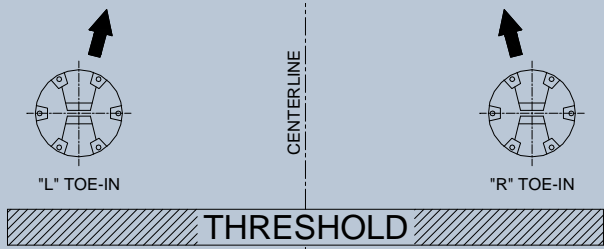

### RENEWAL PARTS FOR LIGHT UNIT

- 1 Dome with prisms and gaskets
- 2 O-Ring for dome (external)
- 3 O-Ring for dome (internal)
- 4 O-Ring for lower cover
- 5 Arctic Kit heater
- 6 Reflector with hardware
- 7 LED module with accessories
- 8 Lower cover with electronic, plug and valve
- 9 Valve for watertightness test
- 10 FAA L-823 plug
- 11 Arctic Kit thermostat
- 12 Prism Gasket
- 13 Prism
- 14 Prism holder gasket
- 15 Mounting plate

Refer to the relevant technical manual for the complete list of the available spare parts

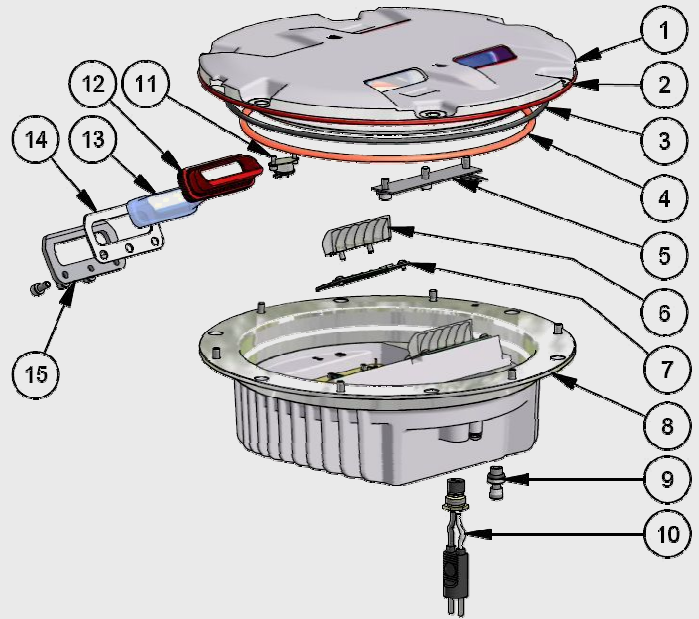

### ACCESSORIES

- 315.1230 Base L-868 type, class IA, size B, 24" deep \*
- 315.1420 Flange ring with pavement dam for L-868 base, size B, with O-Ring and bolts
- 152.8110 Shallow base, 12" dia., one cable lead, with gasket and hardware
- 712.1012 Setting material for shallow base, 5 l
- 712.1013 Setting material for shallow base, 20 l
- 332.4301 Positioning jig for 8"-12" dia. shallow base, without optical device
- 332.4351 Optical device for positioning jig to allow a very precise light unit orientation
- 332.4330 Watertight/shockproof plastic case complete with positioning jig for base and optical device
- 332.4140 Lifting tool (2 pieces to work properly)

\* Sectional bases may be required depending upon the paving technique

For any information about isolating transformers and connectors, please see the specific catalogue pages

### Shipping Weights and Volumes

	Light Unit	Shallow Base
Weight (kg)	7.3	7.3
Volume (m <sup>3</sup> )	0.022	0.022

We reserve the right to change the design or specification data without notice